

FIMER

Export limitation

Table of contents

03	Terms and definitions
04	Requirements
05	Export limitation overview
08	Meter configuration
13	Export limitation configuration
14	Export limitation control setup
17	Export limitation control monitoring
18	Troubleshooting
19	Annex

Terms and definitions

Installer for solar inverters

Mobile app, available for Android and iOS, required to configure the export limitation control.

DHCP

Dynamic Host Configuration Protocol, a protocol where a DHCP server automatically configures the IP settings of the client devices with DHCP enabled.

Consumer reference system

A power reference system where the current absorbed from the grid assumes a positive sign, opposite to the generator reference system.

Control set-point

The active power target of the export limitation control, calculated as the export limit minus a guard band. It cannot exceed the export limit.

Export limit

The maximum amount of active power that is permitted to be injected by the generators into the grid at the Point of Connection.

Export limitation control

The set of export limitation settings and functionality to guarantee that the export limit is not exceeded.

Fallback

An operative mode, with its own settings, that is activated when the PV plant cannot meet the export limit requirement. The fallback must be enabled and properly configured for a fail-safe design.

Fail-safe operations

The capability of the export limitation control to satisfy the export limit requirement also in case of one or more failure scenarios.

Fallback activation time

The amount of time allowed, where the output power measured or evaluated at the Point of Connection can continuously exceed the export limit, before triggering the fallback plan.

Fallback set-point

The amount of active power provided by the inverter when a fallback plan is ongoing.

Fixed IP private address

An IP address not assigned by DHCP where the IP settings (IP Address, IP Gateway, Subnet Mask, DNS) are manually configured by the user.

Generator reference system

A power reference system where the current generated by the PV plant and injected into the grid assumes a positive sign, opposite to the consumer reference system. The export limitation function requires the measurement instruments to be aligned with this reference system.

Guard band

The amount of active power used to guarantee an operating margin for the export limitation control. The guard band also includes the accuracy of the measurement equipment to ensure a reliable export limit at the Point of Connection.

Operative re-entry time

The amount of time the inverter will wait before leaving the fallback when there is no communication with the energy meter. Any event that can trigger the fallback must be continuously inactive during the waiting time to permit to the export limitation control to leave a fallback condition.

Point of Connection (PoC)

The contractual electrical point where export limitation must be ensured.

Control Method

Defines if Export Limitation shall control the output power according to the overall active net power across all phases or the power on each phase.

Aurora Vision

FIMER cloud solution for PV plant monitoring and management.

Requirements

Before enabling the export limitation control the following requirements must be met:

Requirements for the Installer for solar inverters

1. A mobile device, smartphone or tablet, with the following minimum requirements must be available on site:

- Android release 6.0.1 or higher
- iOS release 11.0 or higher.

2. Installer for solar inverters must be correctly installed on the above smartphone.

3. A valid Aurora Vision account must be available. This can be created directly within the app if an Internet connection is available on the mobile device.

4. The above smartphone must be connected to the Internet to perform the login using the Installer for solar inverters. It is possible to log in at an earlier stage.

Points 3 and 4 are required for the login process from the Installer for solar inverters app



NOTE: The Installer for solar inverters mobile app is not compatible with Huawei smartphones or tablets.

Requirements for export limitation control

1. Any inverter involved in export limitation control must be Ethernet connected. However, it is not strictly mandatory to have a direct connection among inverters and networking devices can be installed between inverters. In case of a firewall, this must not block TCP port 5556 or the multicast IP group 239.192.1.1.

2. Any Ethernet IP addresses of inverters involved with the export limitation control must be configured within the same LAN and subnet mask.

3. Energy meter and inverter firmware release must support the export limitation according to Annex 1.

4. A compatible energy meter must be properly installed and configured at the Point of Connection according to meter manual and the **Meter configuration** chapter.

5. A generator reference system must be used according to **Reference system** chapter. However, in case of a different reference system, it is possible to align it as described in **Step 3: verify the reference system and meter data acquisition**.



NOTE: If an inverter is replaced with an already used spare, a connectivity factory reset must be performed before connecting the Ethernet cable to the inverter.



NOTE: The energy meter requires to be the only device acquired by the inverter when a RS-485 direct connection is in place. In case another device should be added through RS-485, this should be connected to another inverter or through Modbus TCP/IP protocol.

Export limitation overview

Many distribution network operators (DNOs) limit the generator size or the amount of power allowed to be exported. Export limitation is a control function that limits the overall power exported into the grid and meets the grid code requirements. When a grid code requires an export limit to be set, it is possible to satisfy the requirement with FIMER inverters and a meter, without the need for external controllers or additional devices. An example of an export limitation with no injection is provided in **Figure 1 - Export limitation example**, where the inverters follow the load consumption to guarantee that no power is exported at the Point of Connection.

Any time the PV power available on the inverters is greater than the load profile (red line), the inverter will reduce its own output power to satisfy the export limit requirement, while the exceeding power will be lost.

Any time the PV power available on the inverters is lower than the load profile (yellow line), the export limit requirement is automatically satisfied, and the inverter will provide the full power available from the solar source.

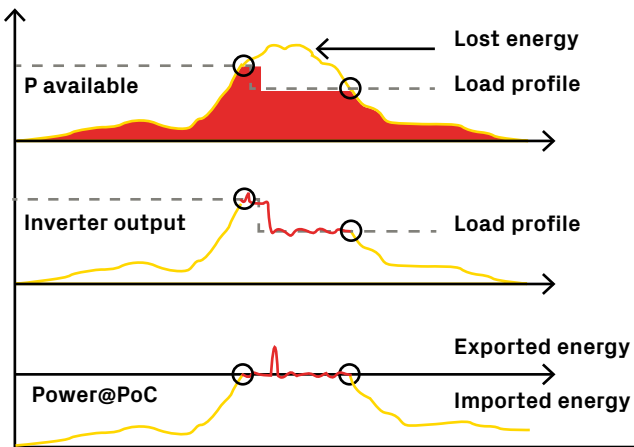

Figure 1 - Export limitation example



NOTE: As shown in **Figure 1 - Export Limitation example**, it is not possible to completely avoid exceeding the export limit in case of a sudden change in the load but the time the power exceeds the export limit is constrained by the control.

Connection diagram

Export limitation curtails the overall power exported from the PV site into the grid as the net power flowing measured at the Point of Connection. To achieve this control it is required to install a compatible energy meter according to Annex 1.

A communication channel between the inverters and meter must be set up. Communication between the inverter and meter can be realized in three different ways:

- a direct serial RS-485 connection between the inverter and energy meter
- a direct Ethernet connection between inverter and energy meter
- through or an existing network infrastructure

Connection between inverters is always realized by an Ethernet connection. Refer to the inverter manuals for details on the possible Ethernet connection options.

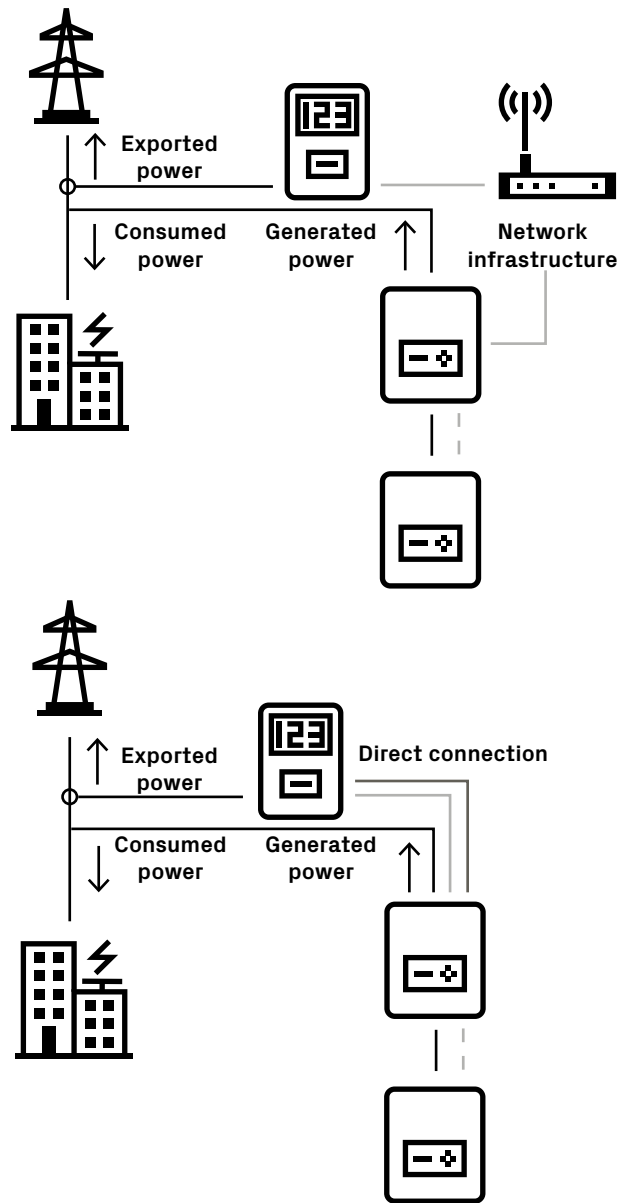

Figure 2 - Export limitation diagram

Distributed control algorithm

The export limitation control adopts a distributed control algorithm to manage exported power. Each inverter involved in the control decides on its own how much power to generate in order to meet the export limit without the presence of any defined master of the control.

The distributed algorithm avoids any issue regarding the status of the controller and allows each inverter to define the best solution to achieve the target.

Continuous communication between the inverters is always required to the share meter and inverter details. To establish this communication, there must be no firewall restrictions on TCP port 5556 or the multicast IP group 239.192.1.1.

Reference System

Export limitation requires a **generator reference system** for all measures and control architecture. A meter must be installed to be compliant with this reference system. If the generator reference system is not applied to the meter, faulty behavior of the control system will occur.

If an energy meter is installed according to the consumer reference system, it is not necessary to modify the meter configuration or CT direction. In this case the reference system can be automatically fixed through the Installer for solar inverters mobile app as described in **Step 3: verify the reference system and meter data acquisition**.

Refer to **Figures 3.1 and 3.2 - Generator VS consumer reference systems** for details about the signs for the required reference system.

Generator reference system

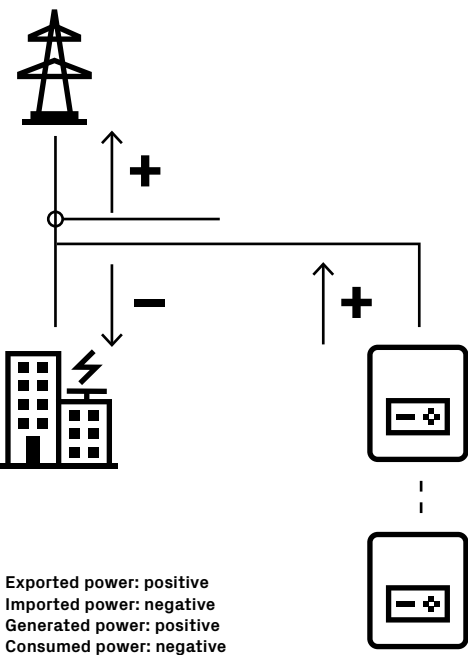

Figure 3.1 - Generator VS consumer reference systems

Consumer reference system

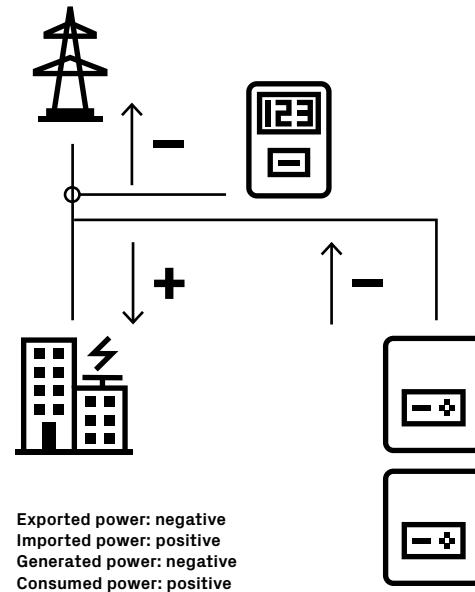

Figure 3.2 - Generator VS consumer reference systems

Export limitation control overview

Export limitation applies a control algorithm to limit the power fed into the grid below a user-defined export limit. The control algorithm will stabilize the power exported to the grid at a lower value defined as a control set point to ensure the required export limitation is satisfied.

Room for maneuver of the control algorithm is implemented by setting a guard band, which is an adjustable value defined as the difference between export limit and the control set point as shown in the following figure.

The guard band therefore represents a safety margin for the control system to avoid exceeding the export limit. This parameter may include the accuracy of the measuring instruments to implement a true and guaranteed export limitation.

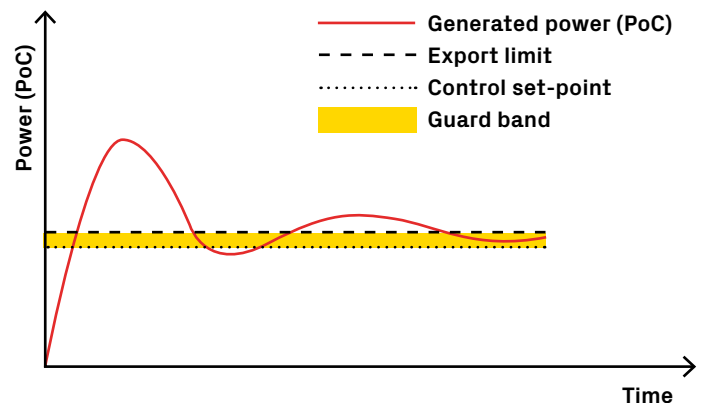

Figure 4 - Export limitation control example

Fail-safe operations

The export limitation control design includes a fallback plan to guarantee failsafe operations: when a critical event happens, each inverter applies a fallback plan to avoid exceeding the export limit.

The export limitation control activates a fallback plan when one of the following triggering conditions are satisfied:

- Communication loss with the energy meter used for export limitation.
- The export limitation is not reachable and the triggering event persists for a time greater of fallback activation time.

When a fallback plan is active, each inverter will independently enter a fallback state providing an output power equal to the fallback set point.

The inverter will keep the output power at the fallback set point until the triggering conditions are persistently unmet for a time greater than the operating re-entry time.

The fallback plan can be enabled and configured by using the Installer for solar inverters app within the export limitation control setup.

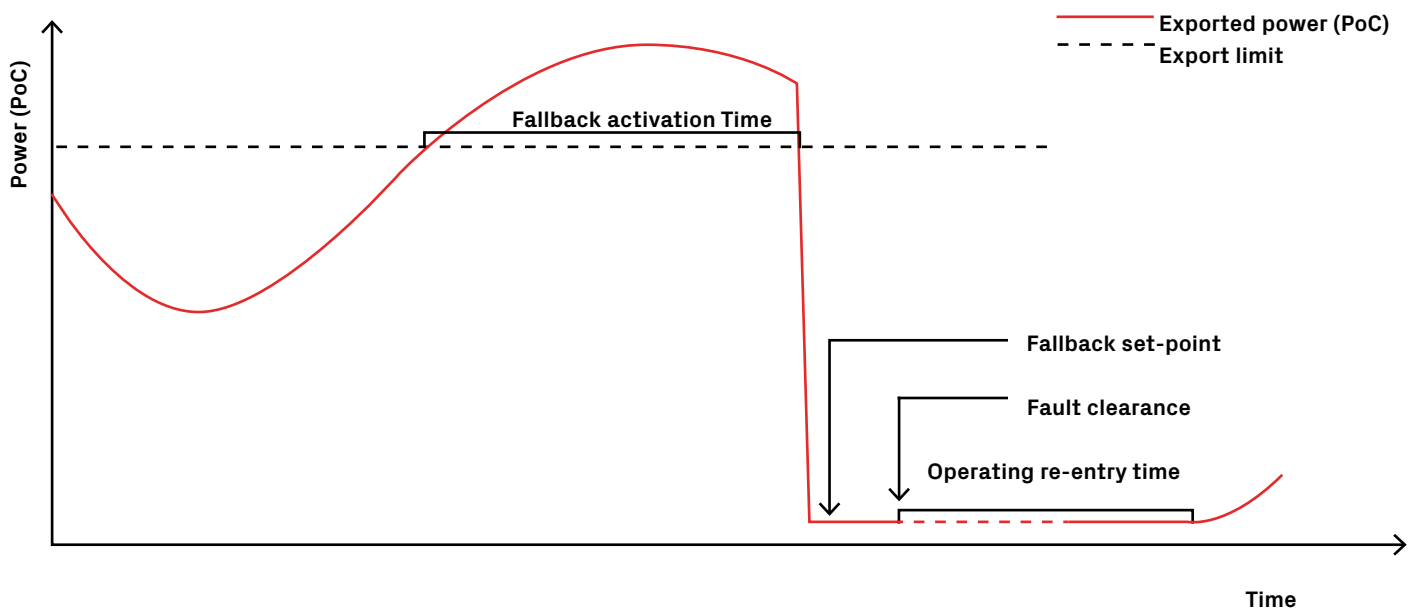

Figure 5 - Fallback example

Control method

Control method shall be selected to configure which active power measure is used as reference for the control.

In case single phase method is selected the control will avoid to exceed the Export Limit for each phase, for example with an Export Limit of 9kW the control will avoid to exceed 3kW per phase. In case Total power method is selected the control will avoid to exceed the Export Limit for the whole total active power, for example with an Export Limit of 9kW the control will avoid to exceed 9kW of total power across the three phases.

The configuration of the Control method shall be chosen to satisfy the requirements of the grid standard, just for example Spanish grid code requires a Power per phase control method whereas Australia requires to apply Total power method.

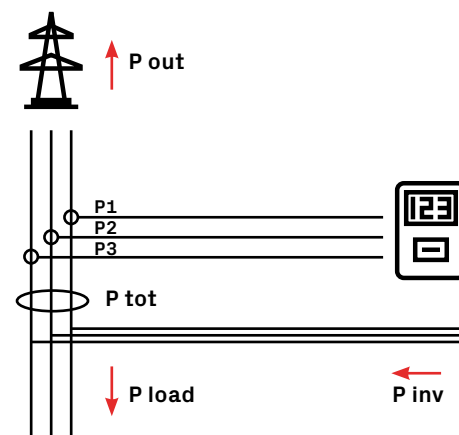

Figure 6: Control method diagram

Meter configuration

Before activating the export limitation function, at least one meter must be properly configured and acquired by the inverters. The meter selected must be compliant with the export limit function according to the compatibility list in **Annex 1: compatibility matrix** and must be installed at the **Point of Connection**.

Refer to the meter manual for the meter installation procedure.



NOTE: The meter current transformer must be installed to be compliant with the **generator reference system**.



NOTE: Inverters can monitor only a single device through RS-485 connection.

Once the electrical installation and serial configuration of the meter is completed, a serial line must connect the meter to an inverter involved in the control. Any inverter compatible with the **Annex 1: compatibility matrix** can be selected for the communication with the energy meter, but it is suggested to choose the inverter next to the Ethernet switch or gateway if the inverters are directly connected to the Internet.

Configuration of the meter through Serial Line

Serial line settings can be left as default but must be noted for the meter configuration procedure with the Installer for solar inverters mobile app as described in the section titled **Meter data acquisition through the Installer for solar inverters**. The following paragraphs provides the pin-out for the serial line connections.

Refer to the following diagrams for further details on connections between energy meter and the inverters.



NOTE: The following pictures show the connection diagram between ABB B24 meter and inverters, the other ABB meters A43/A44/B23 could have the terminal block in a different position but the pinout is the same as B24.

PVS-50/60 and B24 connection diagram

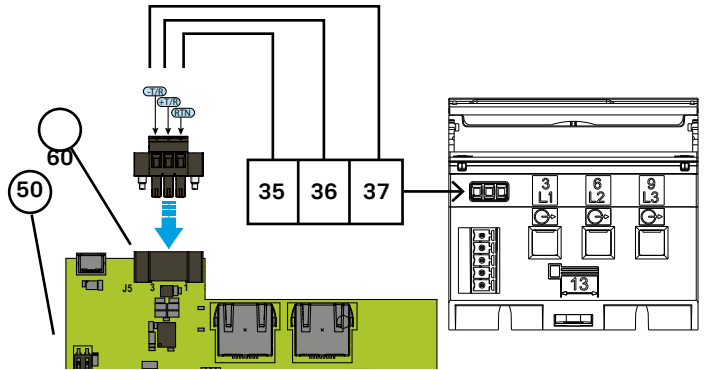

Figure 7 - B24 and PVS-50/60 serial connection diagram



NOTE: The port RS-485 main is used to acquire the meter.

PVS-100/120 and B24 connection diagram

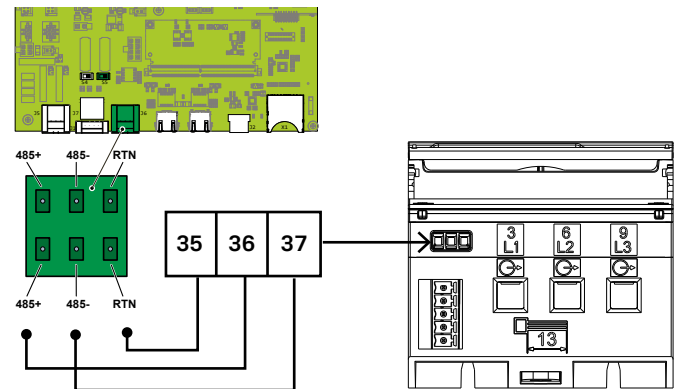
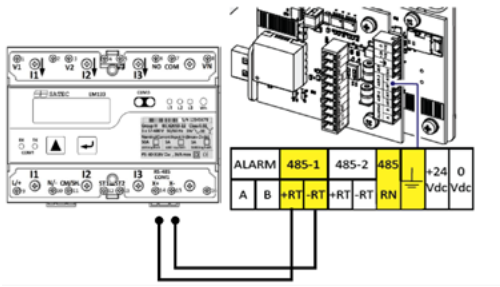

Figure 8 - B24 and PVS-100/120 serial connection diagram

PVS-20-30-33 and meter EM133 connection diagram



PVS-10-12.5-15 and meter EM133 connection diagram

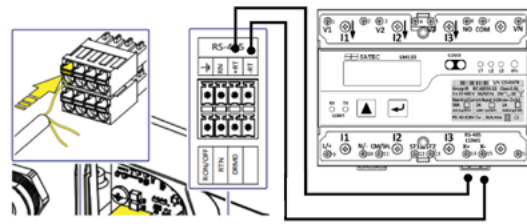

Figure 9 - PVS-20-30-33 and meter EM133 connection diagram

Figure 10 - PVS-10-12.5-15 and meter EM133 connection diagram



Note: Satec meter can be used only in LV systems with a PT/VT ratio equal to one.



Note: Export Limitation require to use measures at high resolution. Resolution can be configured through EM133 display on user-configurable device options.

Device	-TX/RX (A)	+TX/RX (B)	RTN
Energy Meter ABB A44/B24	37	36	35
PVS-50/60 (Main) - Connector J5	-T/R (3)	+T/R (2)	RTN (1)
PVS-100/120 - Connector J6	485-	485+	RTN
PVS-175 - Connector J3	485-	485+	RTN
Energy Meter SATEC EM133	X- (15)	X+ (14)	-
PVS-10/12.5/15	-RT	+RT	RN
PVS-20/30/33 – CCB	-RT	+RT	RN

Table 1 - Serial line connections



NOTE: CT and VT must be properly chosen and configured on the meter. An incorrect configuration will lead to failures and issues with the export limitation control.



NOTE: The meter must be installed at Point of the meter Connection, an incorrect position will lead to fail and issues on export limitation control.

Configuration of the meter through Ethernet

The connection between an Ethernet energy meter and inverter can be established directly by using an existing network as described in the paragraph **Connection diagram**. The energy meter LAN port should be connected to the inverter daisy chain or to a switch or router within the existing network. Inverters and meter must be connected and configured for the same LAN. IP settings must be defined by the customer or site IT manager to avoid conflicts or communication issues.



NOTE: Export limitation requires a fixed IP address for meter to continuously acquire meter measures. For this purpose DHCP must be disabled and a reachable IP address assigned to the meter.

Configuration for ABB M2M-Ethernet

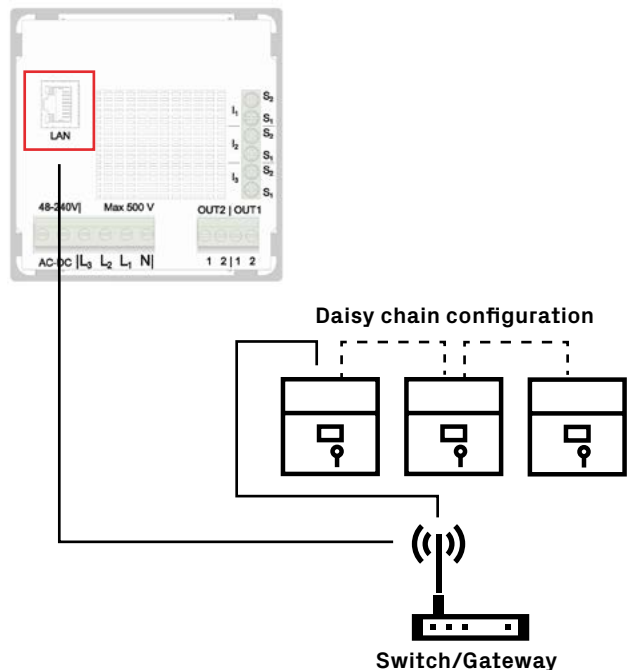

Figure 11 - M2M-Ethernet connection scheme

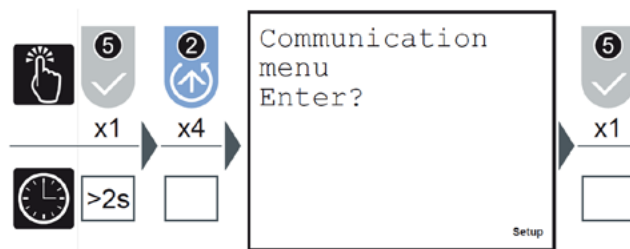

Figure 12 - M2M display Communication menu

The Ethernet configuration of an ABB M2M meter can be done through the display in the Communication menu section or through the internal web server of the meter according to the M2M-Ethernet manual.

In case of web server configuration, the meter login should apply the following default settings:

- DHCP = Disabled
- Default IP = 192.168.1.239
- Host name = ANALYZER-001
- Login Account
 - o Password = admin
 - o Username = admin



NOTE: The export limitation requires a fixed IP address for meter to continuously acquire meter measures. For this purpose DHCP must be disabled and a reachable IP address assigned to the meter.



NOTE: The Modbus TCP protocol must be enabled on M2M meter before activating the export limitation control.

To properly configure and enable the communication channel between the inverter and meter it is required to adjust the IP settings on the **Network** page and check the Modbus Protocol configuration on the **Modbus TCP** page. The IP settings must be defined by the customer or site IT manager to avoid conflicts or communication issues.

The configuration of the meter requires enabling data representation of the active power with negative values. It is mandatory to enable the **generation mode** on the configuration menu before proceeding further according to the following figure or ABB M2M-Ethernet manual.

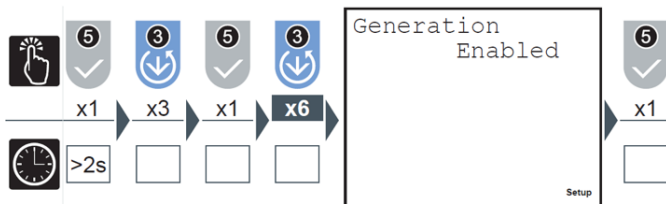

Figure 13 - Generation mode on M2M-Ethernet meter



NOTE: Generation mode allows the exported power and energy to be read. If not enabled the export limitation will not properly control the exported power.

Configuration for ABB M4M-Ethernet

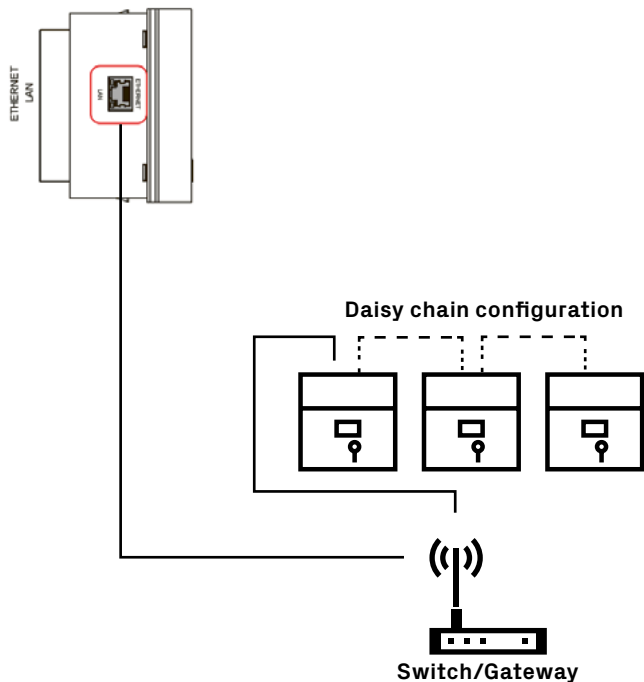

Figure 14 - M4M-Ethernet connection scheme

The Ethernet configuration of an ABB M4M meter can be done through the display in the Home:

- > Configuration
- > Communication
- > Modbus
- > TCP/IP section or through the internal web server of the meter according to the M2M-Ethernet manual.

M4M energy meter should apply the following default settings:

- DHCP = Disabled
- Default IP = 192.168.1.12
- Default Subnet mask = 255.255.255.0
- Default Gateway = 192.168.1.1
- Default TCP Port = 502

Configuration for Satec EM133 meter with TCP communication module

The Ethernet configuration of a Satec EM133 energy meter can be done through the display. To enter programming mode from the display, press and hold the SELECT/ENTER button for more than 5 seconds, then Ethernet settings are available on Net menu

EM133 energy meter should apply the following default settings:

- Default IP Address = 192.168.0.203
- Default Subnet mask = 255.255.255.0
- Default Gateway = 192.168.0.1
- Default TCP Port = 502

Adjust Lan settings (Ip address, Subnet Mask and Gateway) according to the inverter and existing network configuration



Figura 15 - EM 133 connection scheme



Note: Satec meter can be used only in LV systems with a PT/VT ratio equal to one.

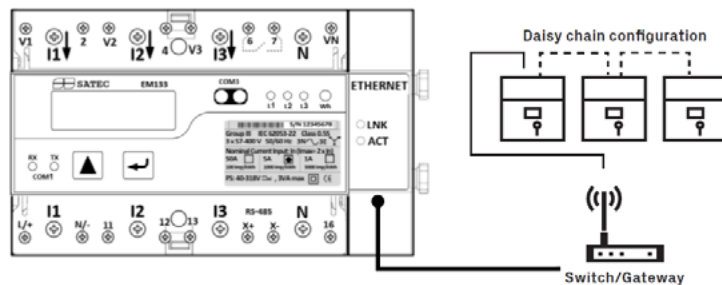

Note: Export Limitation require to use measures at high resolution. Resolution can be configured through EM133 display on user-configurable device options.

Meter data acquisition through the Installer for solar inverters

The export limitation control function requires continuously acquiring meter data to keep the output power below the export limit. To achieve integration between the meter and inverter it is necessary to use the Installer for solar inverters app. On Monitored Devices it is possible to add the data acquisition of an external device, a meter in this case, to the inverter. Select just the inverter that shall acquire the meter. Do this by opening **Monitored Device** on the **Settings** tab.

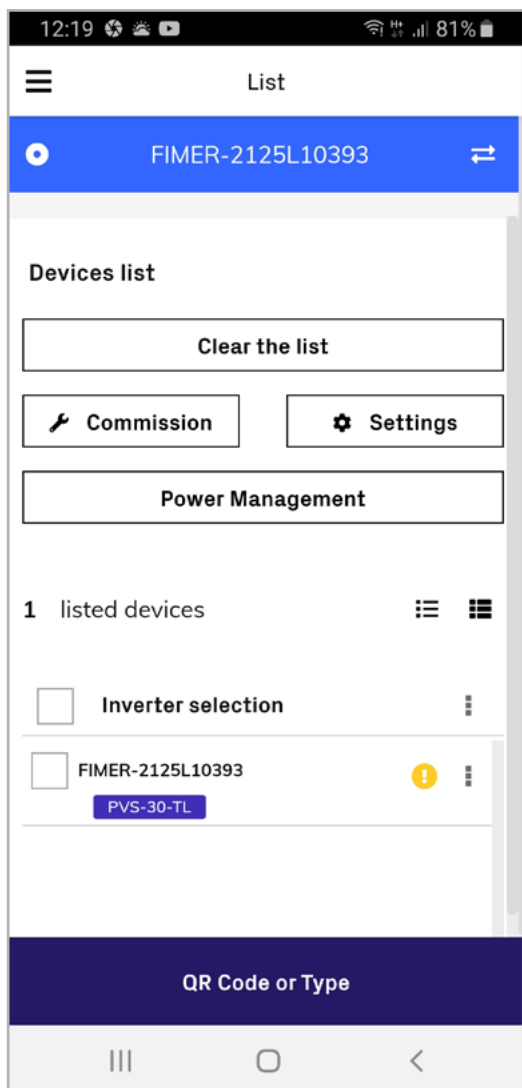

Figure 16 - Single device selection



NOTE: It is suggested to monitor the meter with the inverter directly via Ethernet connected to the router/switch.

Click on **Add Monitored Device** and proceed with the meter settings:

Name: the meter name is an open field used to identify a certain meter, if more are available on the same plant.

Type: select the meter model compatible with the export limitation and to be used for control purpose.

Connection: select the available connection mode for the meter, according to Annex 1.

IP Address (in case of Modbus TCP/IP): provide the IP address configured on the meter to the inverter.

Port (in case of Modbus TCP/IP): the Modbus TCP/IP default port is 502. Use a different value only if the meter TCP/IP port is modified to a different value.

Slave ID: provide the Modbus Slave ID configured on the meter to the inverter.

Baud Rate (in case of Modbus/RS-485): provide the baud rate configured on the meter to the inverter.

Parity (in case of Modbus/RS-485): provide the parity check configured on the meter to the inverter.

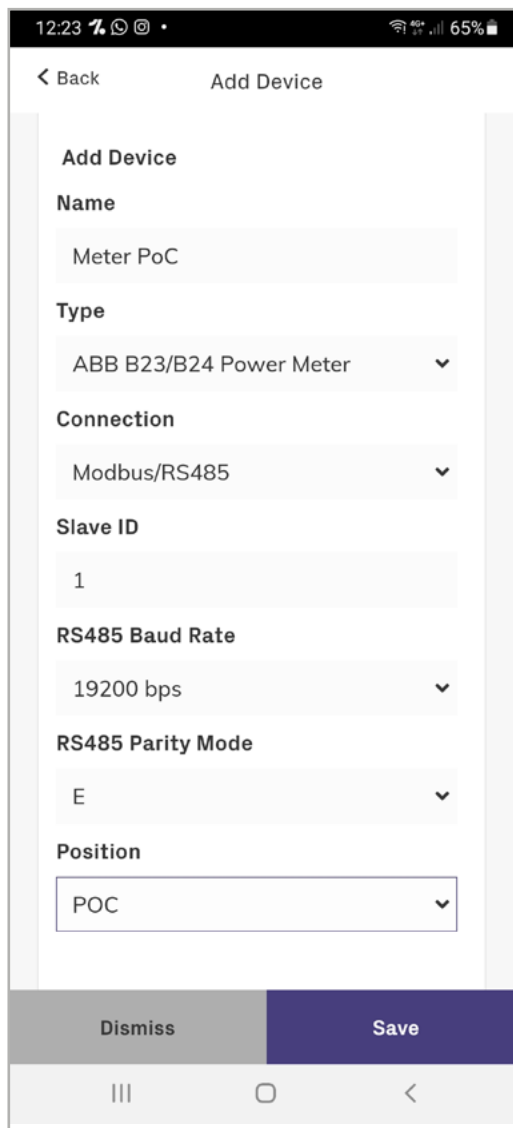

Figure 17 - Device acquisition with the Installer for solar inverters mobile app



NOTE: A44 selection could be not available on the type list, to configure the A44 meter select the B24 option and apply the A44 serial line settings.

Press Save to apply the settings. If the meter communication is up and data is acquired, the status of the meter will become **active**.

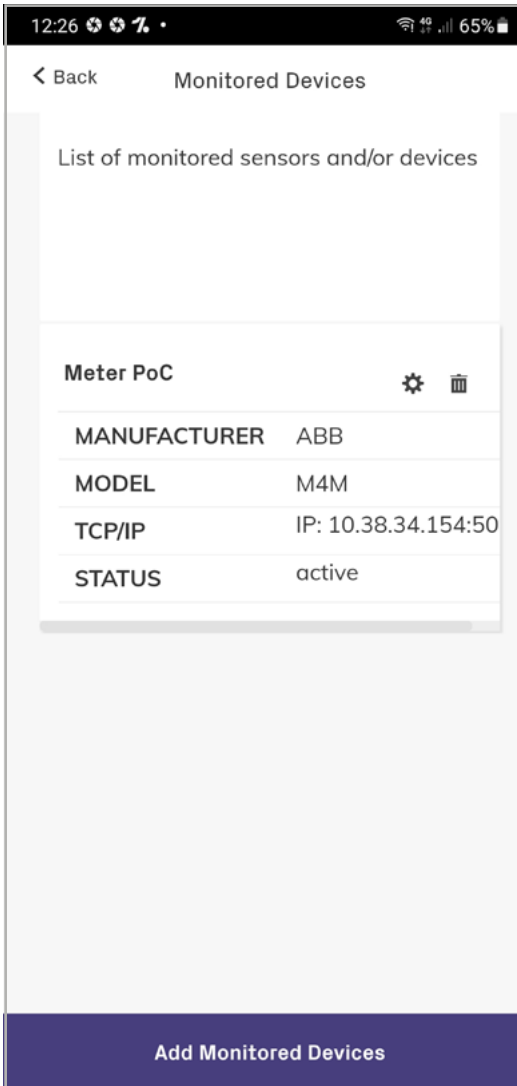

Figure 18 - Monitored device status page

The default settings for energy meters and proposed values are shown in the following table.

Monitored Device parameter	A43/A44/B23/B24	EM133	EM 133 + TCP module	M2M-Ethernet	M4M-Ethernet
Connection protocol	Modbus RTU	Modbus TCP/IP	Modbus TCP/IP	Modbus TCP/IP	Modbus TCP/IP
Slave ID	1	1	Any	Any	Any
RS-485 Baud Rate	19200 bps	19200 bps	-	-	-
RS-485 Parity Mode	Even Parity	No Parity	-	-	-
IP Address	-	-	192.168.0.203	192.168.1.239	192.168.1.12
TCP/IP Port	-	-	502	502	502

Table 2 - Energy meter default settings

Export limitation configuration

Before starting

Before proceeding with the export limitation settings and start-up it is mandatory to complete the following steps:

Inverter commissioning

Any inverter included in the control needs to be commissioned and ready to be grid connected before starting the export limitation configuration.

It is possible to carry out the commissioning process using the Installer for solar inverters app or, in case additional configuration is necessary, through the inverter web user interface.



NOTE: the Installer for solar inverters app will perform the commissioning process on all the inverters in the device list at the same time.

The commissioning process through the web user interface must be repeated for each inverter included on the device list.

Firmware upgrade

All the inverters enabled for export limitation control need to support the control algorithm according to the compatible list included in **Annex 1: compatibility matrix**.

It is strongly suggested to keep the inverters upgraded to the latest firmware and aligned to the same control algorithm release. This functionality can be applied only if all the inverters involved in the control share the latest control algorithm release.



NOTE: The Installer for solar inverters app can perform the firmware upgrade process on all the inverters on the device list at the same time. The firmware upgrade process using the web user interface needs to be repeated for each inverter included on the device list.



NOTE: The Installer for solar inverters app can upgrade inverters only to the latest firmware released, while the web user interface can upgrade the inverter to any firmware, including a downgrade of the firmware.

Ethernet settings

Export limitation requires Ethernet connectivity and IP settings to be properly configured.

Inverters and meters must be on the same LAN and reachable, moreover the inverters are required to be configured for the same subnet mask.



NOTE: The Installer for solar inverters app can apply Ethernet settings to all the inverters in the device list at the same time. Ethernet settings applied by using the web user interface must be repeated for each inverter included on device list.

Meter installation and configuration

The meter must be properly configured according to the instructions for the meter manual for electrical connection and the instructions included in this guide for communication physical connection.

Once the meter is properly installed it is necessary to enable the data acquisition of the meter through the Installer for solar inverters. In case of a serial RS-485 connection between the meter and inverter, the meter must be assigned to the inverter physically connected to the meter, while in the case of an Ethernet connection, the meter can be assigned to any single inverter.



NOTE: The meter Ethernet settings must be written on the inverter. Consequently a fixed private IP address must be assigned. It is allowed to enable DHCP on the meter only if the DHCP server is configured to assign a fixed private IP address associated with the meter's Mac Address.

Export limitation control setup

Export limitation can be configured and enabled only through the Installer for solar inverters. Installation must be compliant with the **Requirements** chapter and all the above pre-requisites must be completed before activating the export limitation control.

Export limitation settings are accessible from the Device List, on the **menu** Power Management/Export Limitation



NOTE: A pop-up message will provide a reminder of the required action to be performed before activating the export limitation control.

Once the pre-requisites are satisfied and confirmed, the Installer for solar inverters app will carry out a scanning process to retrieve all inverters and meters installed on the Local Area Network (LAN).



When Export Limitation and PMU are both active, Export Limitation will be active applying the same configuration except for Export Limit that will be provided by the PMU analog or digital input.

Step 1: select the inverters

All inverters found during the scanning process that are compatible with the export limitation will be shown on the inverter selection list.

Flag all the inverters to be included in the control.



NOTE: It is suggested to check if the overall number of selected inverters match the number that shall be included on Export Limitation and if all the inverters are correctly recognized as commissioned.



NOTE: Inverters are not automatically flagged, pay attention to flag all the inverters that should be included in the control.



NOTE: It is possible to repeat the scanning process with the re-scan button if one or more inverters are missing.

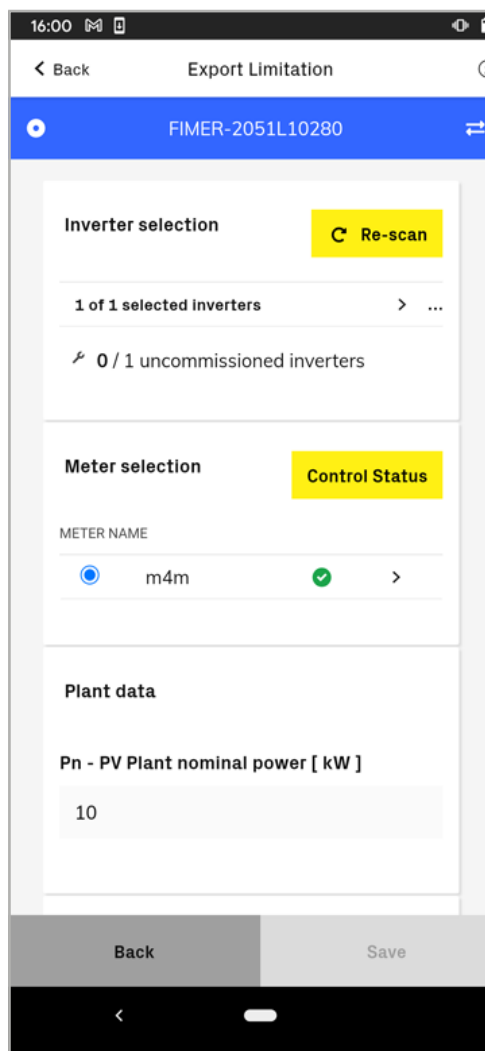

Figure 19 - Inverter selection within the Installer for solar inverters mobile app

Step 2: select the meter

The scanning process automatically finds and lists all meters previously configured in the monitored device section and that are compatible with Export Limitation.

Only the meter installed at the Point of Connection should be selected as a reference meter for the export limitation control. In case more meters are available, it is possible to expand the selection to find out additional details of the meters.

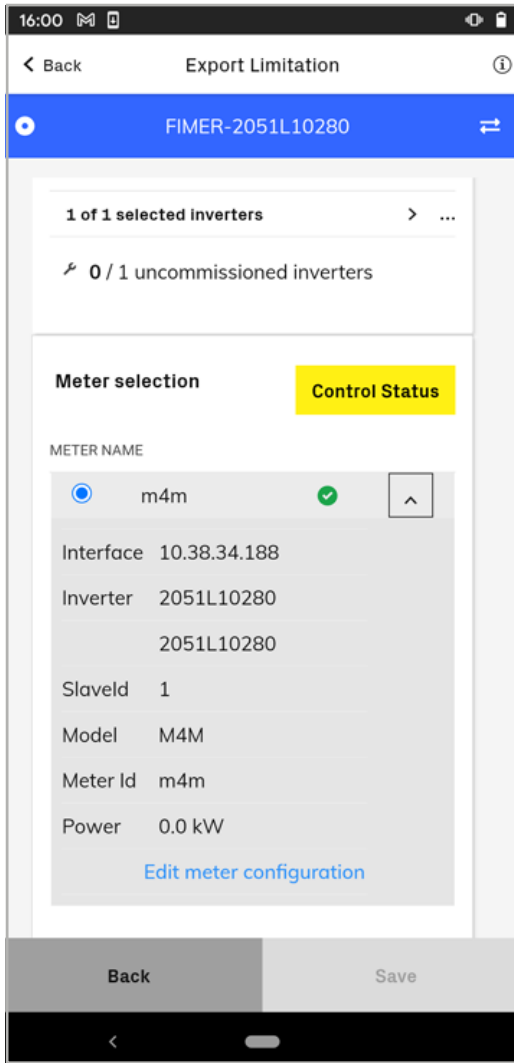

Figure 20 – Energy meter details



NOTE: Meter must be configured with generator reference system. Use the edit configuration link and follow the procedure in the next step to manage the link reference system.

Step 3: verify the reference system and meter data acquisition

If the meter is installed with the **consumer reference system**, it is possible to revert the meter data acquisition to the correct **generator reference system** without the need to rework the installed meter.

The Installer for solar inverters app provides the possibility to change the reference system used for export limitation directly without the need to operate on the installed meter.

Through the **reverse CT** button, it is possible to apply a sign reversion to any current related measure acquired on the meter. To check the reference system, select **edit meter configuration** under meter details and stop inverter productions using the AC disconnection or Remote OFF command.

In case the active power measured on the meter is positive when the inverter does not inject energy, for example during the night, the meter is installed with the **consumer reference system** and it is necessary to press the **reverse CT** button.

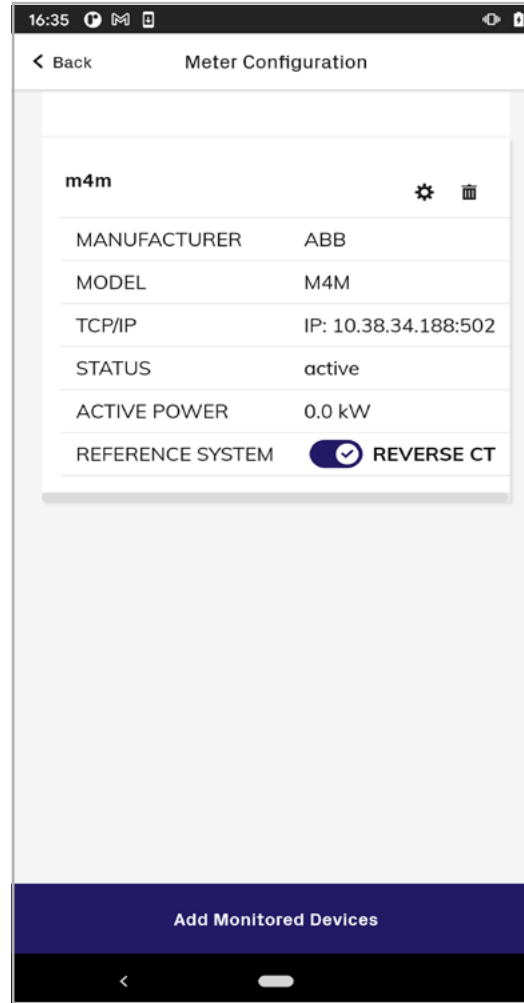

Figure 21 - Editing of energy meter settings

Step 4: configure export limitation

Since all the devices are already selected, it is possible to proceed with export limitation settings.

An **export limit** is expressed as a percentage value of the **PV plant nominal power**, which is used only as reference number.

The PV plant nominal power shall be intended as the reference nominal value used by a specific country to define the limit of exported power. Typically this value is represented by the sum of the nominal AC power of the inverters installed.

The export limitation control utilizes the **export limit** parameter as the threshold value for fail-safe operations. PV plant nominal power is not used in the control system.

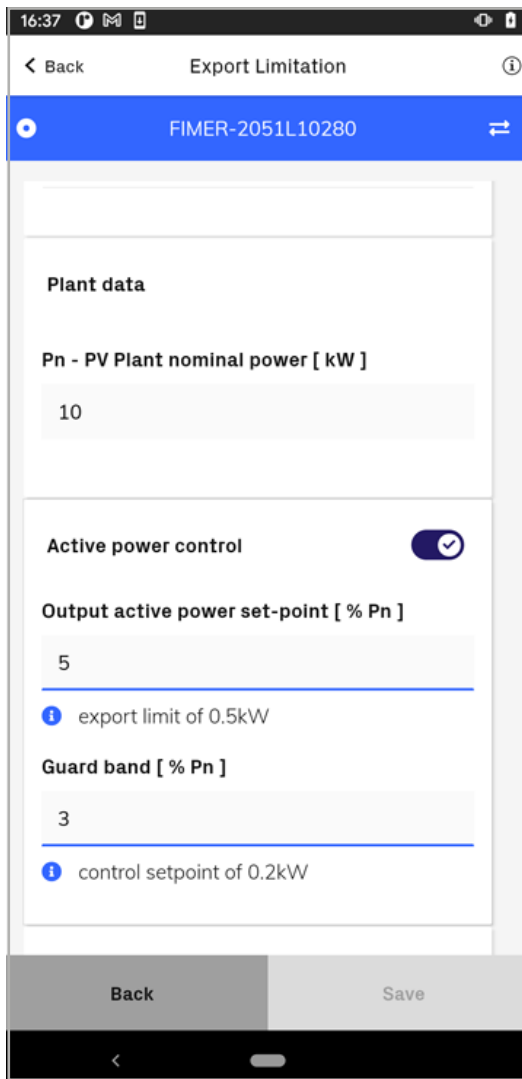

Figure 22 - Export limitation settings

The **guard band** is the control margin used to achieve the export limit and is expressed as a percentage of the **PV plant nominal power**.



NOTE: The guard band shall not be configured at 0% in case fallback is enabled.

The export limitation will control the exported power at the Point of Connection to the **control set point**.

Check the **Export limitation control overview** section for further details.

Export limitation must be enabled by pressing the button next to the **active power control**. The configuration will become active when saved.



NOTE: The meter must be configured with generator reference system. Use the edit configuration link and follow the procedure in **Step 3: verify the reference system and meter data acquisition** to manage the reference system.



NOTE: Remember to switch on the right flag to enable export limitation.

Step 5: configure fallback

Enable the Fallback operation in case grid standard requires to apply a fallback plan as described on section Failsafe operations. In case Fallback is enabled and a triggering condition is continuously satisfied for a time greater than **Fallback Activation Time**, the inverters will activate the fallback plan and immediately will curtail its output power to the **Fallback Setpoint**. Export Limitation control will come back to a normal operating condition when the triggering condition is continuously not satisfied for a time greater than **Operating Re-entry Time**.

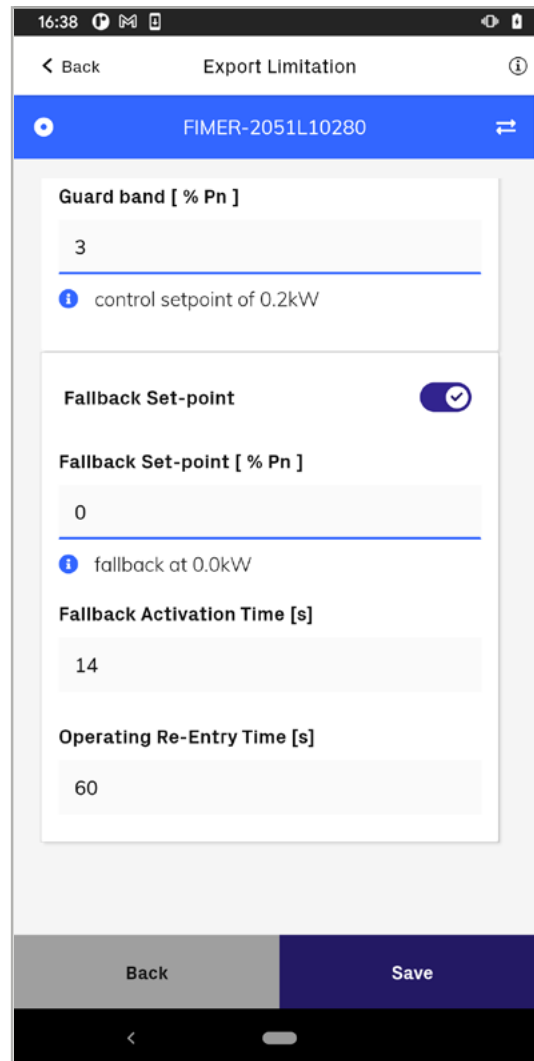

Figure 23 - Fallback settings for fails-safe operations

Step 6: Control method

If supported by inverters, select the Control method required by grid standard:

- Power per phase: in case the control shall avoid to exceed the Export Limit for each phase.
- Total Power: in case the control shall avoid to exceed the Export Limit for the overall power across the three phases.

Total Power is the default setting.

Step 7: apply setting

Press the save button to apply the new settings and start Export Limitation control on all selected inverters.

Export limitation control monitoring

Once the export limitation configuration is completed, it is possible to immediately check the behavior of the export limitation and the real time measures for:

- **Exported Power:** the overall power exported at Point of Connection, provided by the meter.
- **Generated Power:** overall power generated as a sum of the controlled inverter output power.
- **Consumed Power:** calculated power absorbed by the loads.

A colored status bar shows the position of the exported power in respect to the control set point (dotted line) and export limit (continuous line):

If the exported power is less than the control set point, the bar will be filled in blue (CASE A).

If the exported power is within the guard band, in the band between the control set point and the export limit, the bar will be filled in yellow (CASE B).

If the exported power is over the export limit the bar will be filled in red (CASE C).

The bar will refresh about every 5 seconds, while the export limitation control operates at a higher frequency, so the bar does not represent all the power transition within the plant but only a snapshot of the current situation.



NOTE: In case of a positive step change on the load value it is normal to have a momentary filled red bar.

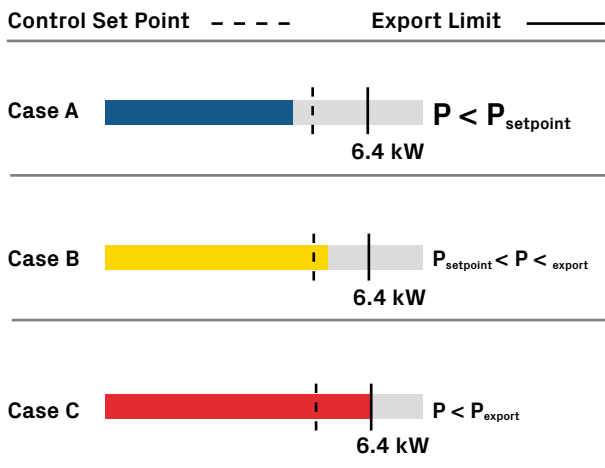

Figure 23 - Export control monitoring



NOTE: The minimum representable value of the status bar is 35% of the nominal power less than the export limit. If the power exported at the Point of Connection is less, the bar will be completely gray.



NOTE: A red colored bar is a triggering condition for a fallback plan.

The inverter section of the control status provides details for each inverter participating in the control. For each inverter it is possible to check:

- **Global, alarm and export limitation state:** an inverter properly working will have a green flag for each state.
- **Inverter output power:** the output power could be different on each inverter being the control algorithm distributed.
- **Derating state and set point:** the derating state is ON when the inverter curtails the output power. The derating set point represents the current power curtailment applied by the inverter.

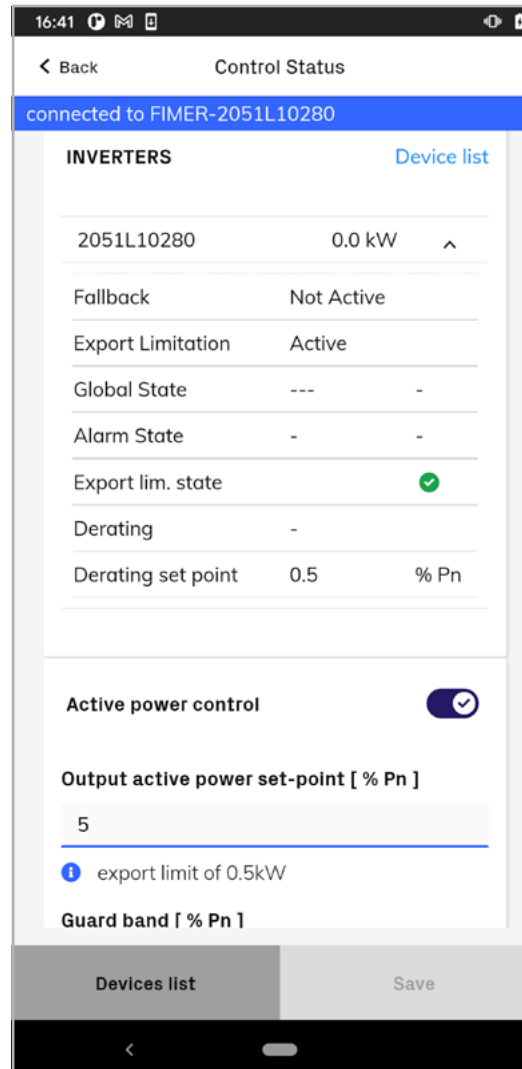

Figure 24 - Export monitoring: inverter status

In case the export limitation control is not acting properly; it is possible to stop the control and change settings to adapt the parameters to increase the efficiency of the system.

Troubleshooting

The PV plant generated power is fixed at 0W and loads are absorbing power.

1. Check the inverter and meter status. An active fallback for missing meter may reduce the generated power.
2. Check the meter position. The meter should be installed at Point of Connection to include the net power exported into the grid. In case the meter is not located at the connection point, but it is installed on the load output or inverter output, the export limitation may be using an incorrect power value.
3. Check the reference system according to **Step 3: verify the Reference System and meter data acquisition.**
The export limitation cannot properly control the exported power if the reference system is not aligned to the generator reference system.
4. Check the meter settings for current (CT) and voltage (VT) transformers, if CT or VT are not properly settled, the meter will not read the effective power flowing through the grid.
5. In the case of an M2M meter and if the **reverse CT** option is enabled, check on the energy meter to see if the **generation mode** is enabled.

PV Plant generated power is fixed at full power and plant export power into the grid

1. Check the meter settings for current (CT) and voltage (VT) transformers. If CT or VT are not properly settled, the meter will not read the effective power flowing through the grid.
2. Check the reference system according to **Step 3: verify the Reference System and meter data acquisition.**
Export limitation cannot properly control the exported power if the reference system is not aligned to the generator reference system.
3. Check the flag for export limitation. If export limitation is not enabled or the configuration is not properly applied, the control will not take place.
4. In case of an M2M meter, check if the **generation mode** is enabled on the energy meter.

PV plant exported power oscillates continuously

1. Oscillations in the export limitation can occur if the inverters enter continuously on fallback, increasing the fallback activation time. If admitted by the grid standard an increase in the guard band will reduce the number of fallback events and consequently the oscillations.
2. Fallback can happen if there is an Ethernet connection failure. An unreliable Ethernet connection can trigger a fallback event independently of the fallback settings. If a fallback is caused by device communication errors, evaluate the integrity of the Ethernet cables using an Ethernet cable tester.
3. Check the meter settings for current (CT) and voltage (VT) transformers. If CT or VT are not properly settled, the meter will not read the effective power flowing through the grid.

It is not possible to retrieve all the inverters during the Export Limitation scan process.

1. If all inverters are not available on the device list, add missing inverters with QR code scan (preferred) or Wifi scan.
2. If all inverters are available on the device list but are lost inside Export Limitation inverter selection check the Ethernet connections and IP settings of inverters. In case of Ethernet ring topology is used, open the ring disconnecting an Ethernet cable from a single inverter and try again.
3. In case the network set up VLANs, apply the same VLAN ID to all the devices or enable the IGMP protocol on network switches to allow the flow of Multicast packets used by the distributed control solution.

Energy meter measures or PoC measures within Control Status page are very low or high.

1. Verify if the CT and VT ratio are properly set within the energy meter.

Aurora Vision does not notify alarms and events about Export Limitation

1. Make sure the Export Limitation category is included in the Event Profile associated with the monitored plant within Aurora Vision Plant Portfolio Manager.

Annex

Annex 1: compatibility matrix

Table 3 - Meter compatibility matrix

Meter model	PN for order	Connection mode	CT available	VT available	Minimum Logger Firmware Release					Mounting
					PVS-100/120	PVS-50/60	PVS-175	PVS-10/12.5/15	PVS-20/30/33	
ABB - B24 212-100	2CMA100180R1000	RS 485	√	x	0.14.9	1.6.9	x	2124B	2117E	Din bar
ABB - B24 3 5 2 -100	2CMA100183R1000	RS 485	√	x	0.14.9	1.6.9	x	2124B	2117E	Din bar
ABB - A44 212-100	2CMA170534R1000	RS 485	√	√	0.14.9	1.6.9	√	2124B	2117E	Din bar
ABB - A44 352-100	2CMA170537R1000	RS 485	√	v	0.14.9	1.6.9	√	2124B	2117E	Din bar
ABB - M2M-Ethernet	2CSG299903R4052	Ethernet	√	√	0.14.9	1.6.9	0.4.12	2124B	2117E	Front panel
ABB - M4M-20-Ethernet	2CSG204471R4051	Ethernet	√	√	1.0.8	1.8.7	0.4.12	2124B	2117E	Front panel
ABB - M4M-30-Ethernet	2CSG274681R4051	Ethernet	√	√	1.0.8	1.8.7	0.4.12	2124B	2117E	Front panel
SATEC-EM 133	-	RS 485 or Ethernet	√	√	x	x	x	2124B	2117E	Din bar

Table 4 - Inverter compatibility matrix

Inverter model	Minimum Inverter Firmware Release	Minimum Logger Firmware Release	Minimum Installer for solar Release
PVS-10-TL	2124B	Not necessary	3.0.1
PVS-12.5-TL	2124B	Not necessary	3.0.1
PVS-15-TL	2124B	Not necessary	3.0.1
PVS-20-TL	2117E	Not necessary	3.0.1
PVS-30-TL	2117E	Not necessary	3.0.1
PVS-33-TL	2117E	Not necessary	3.0.1
PVS-50-TL	1901B	1.6.9	2.1.13
PVS-60-TL	1901C	1.6.9	2.1.13
PVS-100-TL	1912B	0.14.9	2.1.13
PVS-120-TL	1912C	0.14.9	2.1.13
PVS-175-TL	1922D	0.4.12	2.1.19

Annex 2: track release changes

Table 5 - Guideline track change

Guideline revision	Date	Export Limit release	Revision note
1.0	05-Jun-2019	0.4.6	First release
1.1	30-Mar-2021		Aligned document to FIMER brand included the compatibility with M4M-Ethernet meter and PVS-175-TL
1.2	13-Sep-2021		Included the compatibility with A43, A44 and EM133 meters Included the compatibility with PVS10/12.5/15/20/30/33 New functionality: Control Method and support to PMU

Annex 3: list of figures and tables

- Figure 1 - Export limitation example
- Figure 2 - Export limitation diagram
- Figure 3.1 - Generator VS consumer reference systems
- Figure 3.2 - Generator VS consumer reference systems
- Figure 4 - Export limitation control example
- Figure 5 - Fallback example
- Figure 6: Control method diagram
- Figure 7 - B24 and PVS-50/60 serial connection diagram
- Figure 8 - B24 and PVS-100/120 serial connection diagram
- Figure 9 - PVS-20-30-33 and meter EM133 connection diagram
- Figure 10 - PVS-10-12.5-15 e meter EM133 connection diagram
- Figure 11 - M2M-Ethernet connection scheme
- Figure 12 - M2M display communication menu
- Figure 13 - Generation mode on M2M-Ethernet meter
- Figure 14 - M4M-Ethernet connection scheme
- Figure 15 - EM 133 connection scheme
- Figure 16 - Single device selection
- Figure 17 - Device acquisition with the Installer for solar inverters mobile app
- Figure 18 - Monitored device status page
- Figure 19 - Inverter selection within the Installer for solar inverters mobile app
- Figure 20 – Energy meter details
- Figure 21 - Editing of energy meter settings
- Figure 22 - Export limitation settings
- Figure 23 - Fallback settings for fails-safe operations
- Figure 24 - Export monitoring: inverter status

Tables list

- Table 1 - Serial line connections
- Table 2 - Energy meter default settings
- Table 3 - Meter compatibility matrix
- Table 4 - Inverter compatibility matrix
- Table 5 - Guideline track change