

FIMER

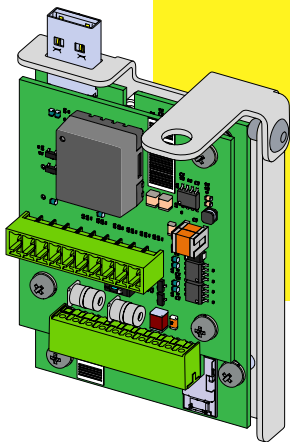

Solar Inverter

PVS-20/30/33-CCB

Quick Installation Guide

1. Functionalities

The PVS-20/30/33-CCB (communication and control board) is an expansion accessory board for PVS-20/30/33 inverter family that adds the following capabilities to the inverter:

- RS 485-1 secondary communication line for PVI/TRIO emulation protocols
- RS 485-2 main communication line (master or slave)
- Active output power limitation via digital inputs (PMU mode)
- Active output power limitation and reactive power management functions via analogical inputs (PMU).
- Auxiliary power supply (24Vdc/80mA) for external devices (ex: VSN800 Weather Station).

2. Main components

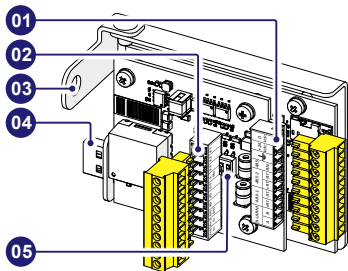

Main components

- | | |
|----|---|
| 01 | Signal connector J1
(Alarm relay, RS-485 and 24V power supply) |
| 02 | Signal connector J3
(Digital and Analog inputs) |
| 03 | Mounting bracket |
| 04 | USB connector |
| 05 | RS-485 line termination switches |

3. Supplied component list

Components available in the kit	Q.ty
---------------------------------	------

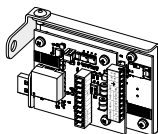

Communication and Control Board 1
(PVS-20/30/33-CCB)

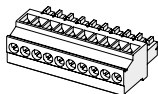

Counterpart J1 connector (L-shaped) 1

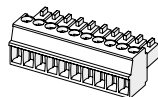

Counterpart J3 connector (straight) 1



M6 screw with washer for mechanical securing 1



Technical documentation 1

4. Assembly instructions

The PVS-20/30/33-CCB must be installed inside the Signals connection box (08) on the lower part of the PVS-20/30/33-TL inverter.

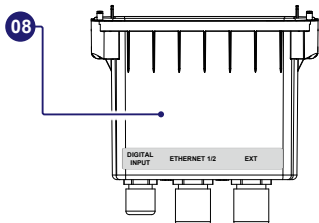

PVS-20/30/33-CCB must be connected to inverter USB connector (10) located under the Signals connection box (08).

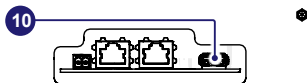

The connection cables of the PVS-20/30/33-CCB must be passed through the EXT cable gland (22) of the signals connection box (08). The cable gland is equipped with a three-holes gasket that can be removed in case of using a single multicore cable. Signal cables characteristics:

EXT cable gland (22)- M25

Multi cables installation (with three-hole gasket)	4...6 mm (each hole)
Single cable installation (without three-hole gasket)	10...17mm

J1 and J3 screw terminal blocks

Signal connectors wires	0.14...1.5mm ²
-------------------------	---------------------------

Tightening torques

EXT cable gland (22)- M25	7.5 Nm
Screw terminal blocks (J1 and J3)	0.22...0.25Nm

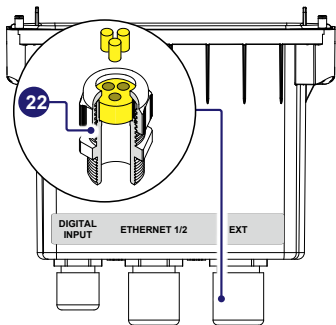

4.1 PVS-20/30/33-CCB installation procedure

⚠ WARNING – The installation of the PVS-20/30/33-CCB must be carried out with the inverter disconnected from the grid and from the photovoltaic generator.

• Remove the Signals connection box (08) by unscrewing the 4 retain screws.

⚠ ATTENTION – If any cable is installed on the other two cable glands remember to unscrew it in order to slide the cables freely.

• Connect the PVS-20/30/33-CCB to the USB connector (10).

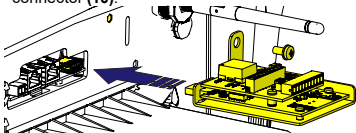

• Tighten the screw supplied to lock the PVS-20/30/33-CCB in place (torque 4Nm).

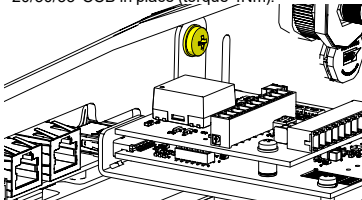

⚠ ATTENTION – The PVS-20/30/33-CCB, once installed, will be detected at the next restart of the inverter.

📌 NOTE – Available signals are highlighted in yellow. See the dedicated paragraphs on this guide.

4.2 Communication and control signals connection

- Take the Signals connection box (08), unscrew and remove the EXT cable gland (22) ring.
- Remove the three-holes gasket from the EXT cable gland (22).
- Remove the plug/s (plastic cylinder/s) from the gasket.

⚠ ATTENTION – Skip this step in case of use of a single multicore cable.

- Insert the cable/s through the EXT cable gland (22) ring.
- Install the three-holes gasket on the cable/s and reinstall it inside the cable gland.

⚠ ATTENTION – Skip this step in case of use of a single multicore cable.

- Insert the cable/s inside the Signals connection box (08) through the EXT cable gland (22).
- Reinstall the cable gland ring without firmly tighten it.
- Connect the wires on the supplied mating connectors following the pin out indicated on the labels applied on the board:
 - Counterpart J1 connector L-shaped connector.
 - Counterpart J3 connector straight connector.

- Install the mating connectors on the respective connectors on the PVS-20/30/33-CCB.

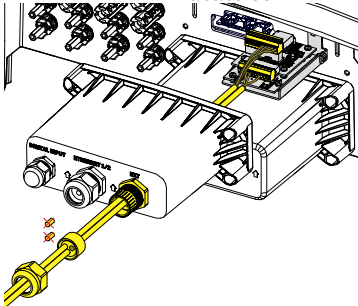

- Install the signals connection box (08) by screwing the 4 locking screws present on it.
- Firmly tighten the EXT cable gland (22) ring (torques 7.5Nm).

⚠ ATTENTION – If any cable is installed on the other two cable glands remember to screw it.

An1	An2	AN	K6	K5	K4	K	K3	K2	K1
In	In	RN				RN			

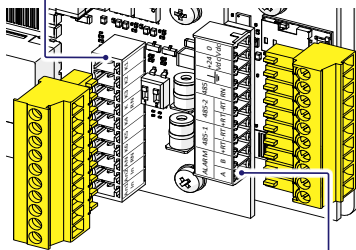

ALARM	485-1	485-2	485		+24	0
A	B	+RT	-RT	+RT	-RT	RN
						Vdc
						Vdc

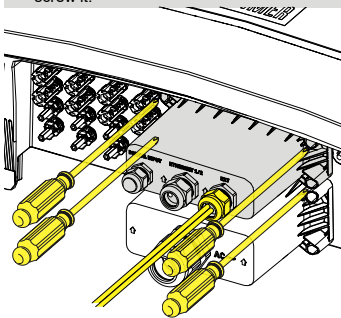

5. RS-485 lines (1 & 2)

The PVS-20/30/33-CCB RS-485 lines can be used in different adjustable modalities as described in the below paragraph.

5.1 RS 485-1 line

PVI/TRIO emulation mode can be enabled, on serial line RS 485-1, to emulate the communication protocols of a TRIO-20/27.6 inverter and keep the compatibility with external monitoring systems.

NOTE – Due to the differences between PVS and TRIO inverter families some restrictions apply on the availability of exposed measures on legacy communication protocols as described on the dedicated PVI/TRIO Emulation mode application guideline.

Emulation protocols over serial line RS 485-1 can be selected and configured on mobile APP "Installer for solar inverters" or Web User Interface.

NOTE – PVI/TRIO emulation mode shall be applied only for retrofit purpose to keep the compatibility with existing systems.

NOTE – Any configuration must be done using the APP "Installer for solar inverters" or Web User Interface. For more info refer to the product manual at www.fimer.com

5.2 RS 485-2

Automatic settings of network parameters at power on, embedded logging capability, automatic logger-free transferring of data to Aurora Vision cloud and remote firmware update are provided over TCP/IP connectivity (Ethernet and/or Wi-fi) bus only.

5.2.1 Third party system (Slave)

The use of the inverters over the 485-2 line is recommended in case of using third party RS-485 control systems (slave mode).

NOTE – RS-485 line supports Modbus/RTU SUNSPEC compliant Modbus protocol.

NOTE – Any configuration must be done using the APP "Installer for solar inverters" or Web User Interface. For more info refer to the product manual at www.fimer.com

5.2.2 External devices (Master)

The 485-2 port can be used for connecting supported devices (like VSN800 Weather Station, meter, etc) and have the inverter acting as datalogger for the connected devices.



In this case data from accessories will be logged and transferred to FIMER Aurora Vision cloud by inverter itself (master mode).

NOTE – Please refer to FIMER web site www.fimer.com for getting info on accessory supported.

NOTE – Any configuration must be done using the APP "Installer for solar inverters" or Web User Interface. For more info refer to the product manual at www.fimer.com

5.3 RS 485 lines connection

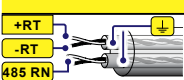
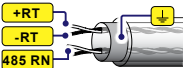
In order to connect one or more units (daisy-chain) on a serial line the correspondence between the signals must be observe, as for the table below:

	Signal	Symbol
	Positive data	+RT
	Negative data	-RT
	Reference	485 RN
	Shield	

ATTENTION – Shield continuity must be provided along the communication line and must be grounded in a single point.

ATTENTION – Use a shielded twisted pair cable with characteristic impedance of Z0=120 Ohm in case of long distance connection.

5.3.1 RS 485-1 line connection

The RS 485-1 serial communication line is available on the PVS-20/30/33-CCB terminal blocks +RT (485-1), -RT (485-1), 485 RN and \perp .

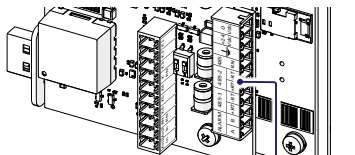

ALARM	485-1	485-2	485		+24 Vdc	0 Vdc
A	B	+RT	-RT	+RT	-RT	RN

5.3.2 RS 485-2 line connection

The RS 485-2 serial communication line is available on the PVS-20/30/33-CCB terminal blocks +RT (485-2), -RT (485-2), 485 RN and \perp .

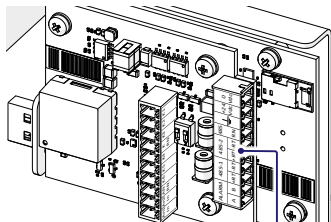

ALARM		485-1		485-2		485		+24 Vdc	0 Vdc
A	B	+RT	-RT	+RT	-RT	RN			

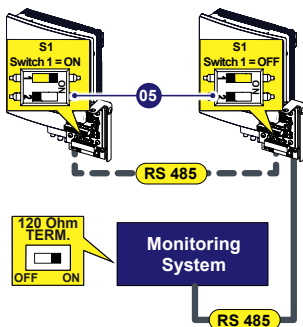

NOTE – The communication line must also be terminated on the first element of the chain which normally corresponds to the "third party system".

5.4 RS 485 lines termination

To activate the 120Ohm termination resistance of the communication lines set the switch 1 or 2, of S1 (05) component, in ON position:

- Switch 1 > RS 485-1
- Switch 2 > RS 485-2

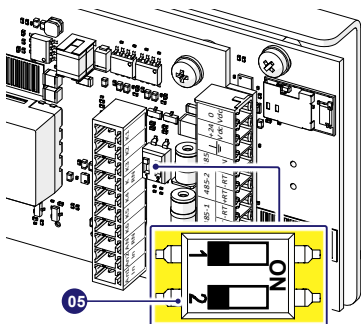

NOTE – Activate the termination resistance on the final unit of the chain.

NOTE – Activate the switch also in case of a single unit installed

6. Auxiliary power supply

The PVS-20/30/33-CCB is equipped with a 24Vdc power supply for external devices directly connected to the 485-2 communication line.

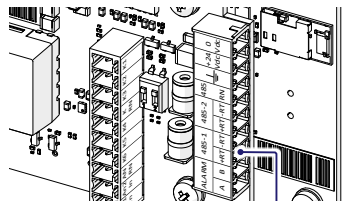

ALARM		485-1		485-2		485		+24 Vdc	0 Vdc
A	B	+RT	-RT	+RT	-RT	RN			

NOTE – The maximum output current is 80mA

7. PMU Mode

The PVS-20/30/33-CCB allow the possibility to manage the active power limitation, the reactive power and power factor control.

Digital and analogue input levels translates into corresponding control commands according to the German Renewable Energy Sources Act (EEG).

NOTE – Inverter receiving the specific ripple control signal provides to send to all PVS string inverters, connected to the same Ethernet line, the corresponding active and/or reactive power command.

NOTE – In case of multiple inverters, connected via Ethernet one to each other, only one PVS-20/30/33-CCB shall activate PMU mode.

7.1 Analogue inputs

The analogue input used for the **active power limitation** function is AN1.

The analogue input for the **reactive power control** function is AN2.

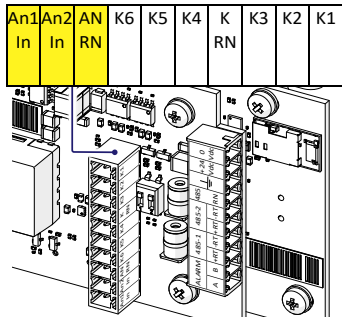

The active power limitation manages the output active power according to the current (4...20 mA) signal applied, as shown on the characteristics

below:

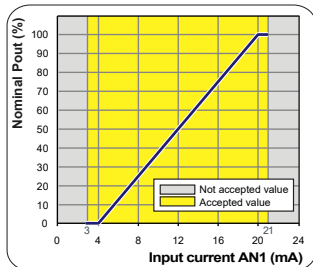

The reactive power limitation manages the output active power according to the current (4...20 mA) signal.

Two reactive power management modes are available:

- Fixed Var → Based as % of the inverter apparent power.
- Fixed PF → $\text{Cos}(\phi)$ based on the instantaneous output power

The inverter reactive power management is applied as shown in the characteristics below:

Fixed Var

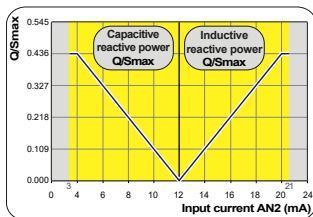

Fixed PF

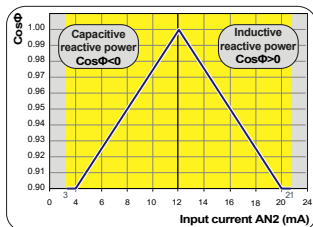

7.2 Digital inputs

The active power control via digital inputs allow to set the maximum active output power as % of the inverter nominal power.

The digital inputs used for the active power limitation function are "K1, K2, K3, K4 and K RN".

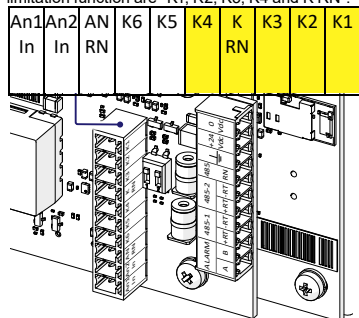

• Connect the wires according to the following table. The input that is "Closed" must be short circuited with the "K RN" terminal.

K1	K2	K3	K4	Maximum active power
Closed	Open	Open	Open	100 %P _{nom}
Open	Closed	Open	Open	60 %P _{nom}
Open	Open	Closed	Open	30 %P _{nom}
Open	Open	Open	Closed	0 %P _{nom}

7.3 PMU integration with Export Limitation algorithm

The interaction between PMU and Export Limitation is shown in the table below.

PMU	Export limitation	Behavior
OFF	OFF	Active Power control disabled
OFF	ON	Active Power managed by Export Limitation
ON	OFF	Active Power managed as generation control with PMU settings
ON	ON	Active Power managed by Export Limitation with Export Limit defined by PMU analogue or digital signal

NOTE – When Export Limitation and PMU are both enabled then Export Limitation will be active with the Export Limit defined by the PMU analogue or digital signal.

NOTE – Only one PMU shall be used to define the Export Limit. Any constraint that apply to the Export Limitation configuration shall still be respected.

NOTE – PMU control with Export Limitation can be configured only with the Installer for Solar Inverters mobile app.



For more information please contact your local FIMER representative or visit:

fimer.com

We reserve the right to make technical changes or modify the contents of this document without prior notice. With regard to purchase orders, the agreed particulars shall prevail. FIMER does not accept any responsibility whatsoever for potential errors or possible lack of information in this document.

We reserve all rights in this document and in the subject matter and illustrations contained therein. Any reproduction, disclosure to third parties or utilization of its contents – in whole or in parts – is forbidden without prior written consent of FIMER. Copyright© 2024 FIMER. All rights reserved.